

Front View

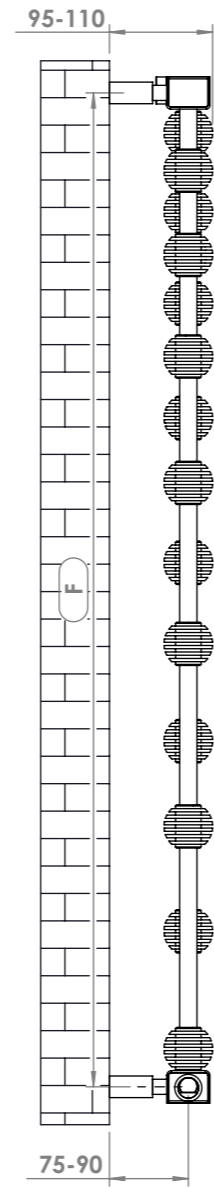

Side View

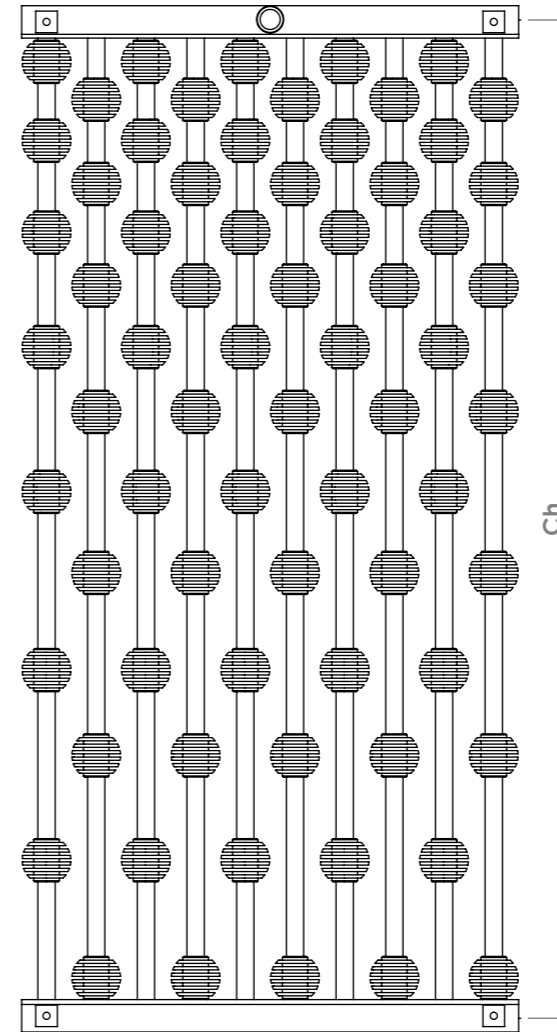



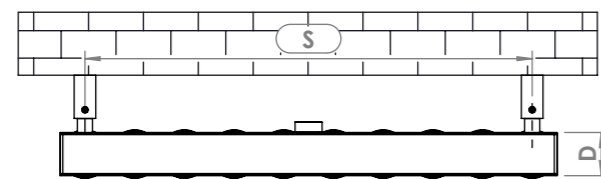
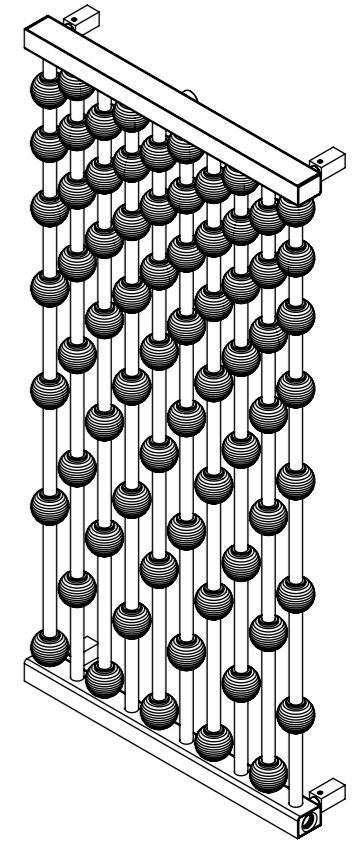



Back View



Top View

**Installation Accessories:**

-  x4       x4
-  x4       x4
-  x4       x1

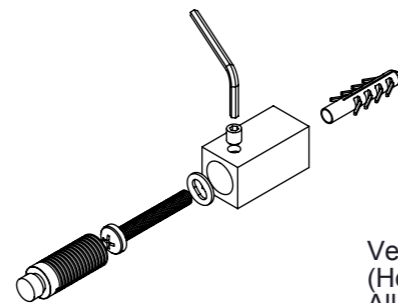

Vertical mount  
(Horizontal mount is possible by special order)  
All Dimensions are in mm  
Max. Working Pressure: 10 Bar  
Max. Working Temperature: 95° C  
Inlet / Outlet : 1/2" BSP  
Fuel : E/H/D

**Plumbing Position:**

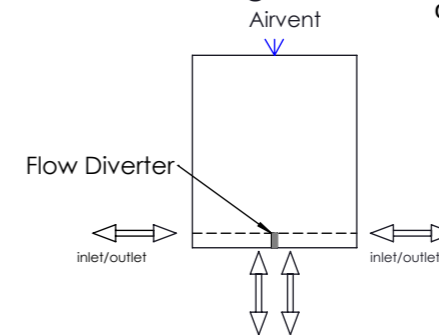

When mounting vertically, please observe that the collector fitted with a flow diverter is mounted at the bottom. This can be verified by visually checking or by referring to the installation diagram

When mounting horizontally, please knock through the centre hole of the diverter using a suitable rod. Please remove the disk if it comes loose and can be removed from a tapping

Manufacturing Tolerance : - 5 mm

PRODUCT CODE	Height	Length	Depth	Pipe Centres Vertical	Pipe Centres Horizontal	Bracket Centres	
	H mm	L mm	D mm	C-C1 mm	Ch mm	F mm	S mm
AB10-70	950	460	45	50-550	920	920	414
AB16-95	1600	460	45	50-550	1570	1570	414