

BOLERO

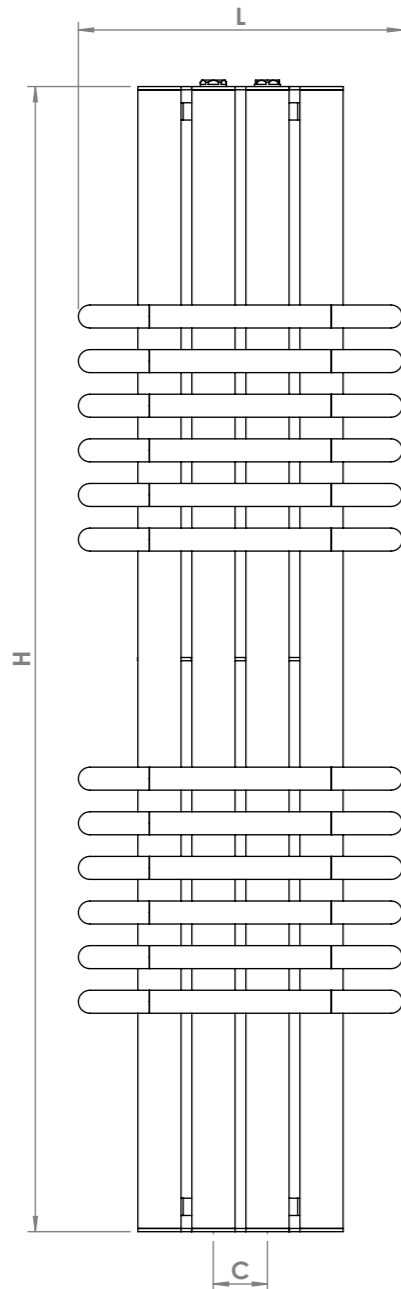

Front View

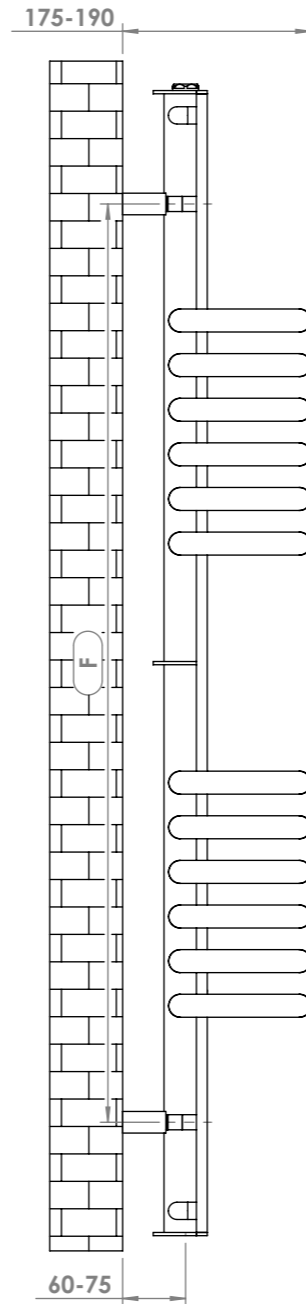

Side View

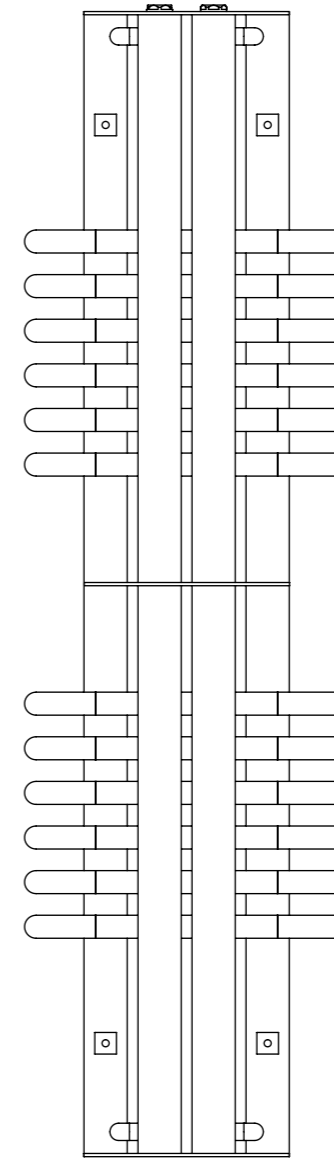

Back View

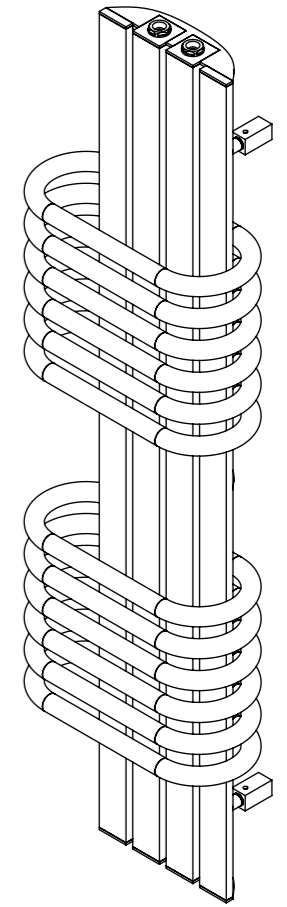



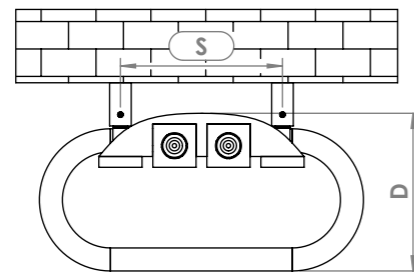
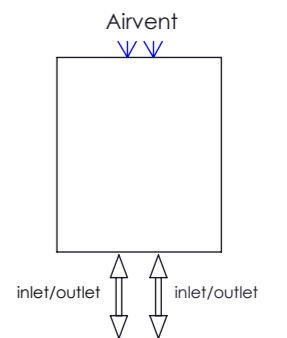



Plumbing Position:



Top View

Installation Accessories:

-  x4  x4
-  x4  x4
-  x4  x1

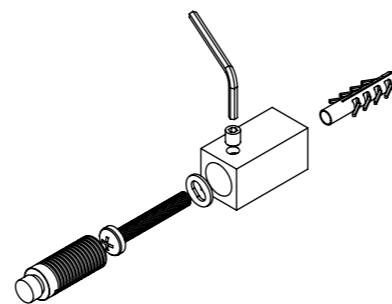

Vertical mount
 All Dimensions are in mm
 Max. Working Pressure: 10 Bar
 Max. Working Temperature: 95° C
 Inlet / Outlet : 1/2" BSP
 Fuel : E/H/D

Manufacturing Tolerance : - 5 mm

PRODUCT CODE	Height	Length	Depth	Pipe Centres	Bracket Centres	
	H mm	L mm	D mm	C mm	F mm	S mm
BOL1	630	300	150	50	420	150
BOL2	1060	300	150	50	850	150
BOL3	1500	300	150	50	1290	150