

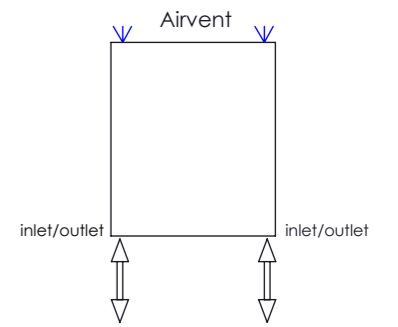





**Plumbing Position:**

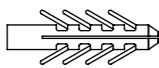

Vertical mount  
 All Dimensions are in mm  
 Max. Working Pressure: 10 Bar  
 Max. Working Temperature: 95° C  
 Inlet / Outlet : 1/2" BSP  
 Fuel : E/H/D

Manufacturing Tolerance : - 5 mm

**Installation Accessories:**

-  x4       x4
-  x4       x4
-  x4       x1

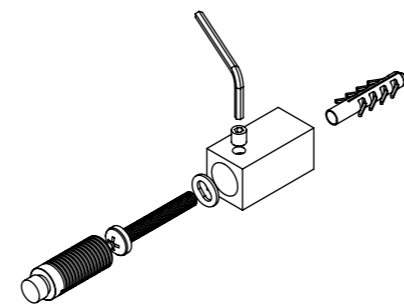

PRODUCT CODE	Height	Length	Depth	Pipe Centres	Bracket Centres	
	H mm	L mm	D mm	C mm	F mm	S mm
CEN5C7	690	500	60	470	520	470
CEN5C11	1100	500	60	470	930	470
CEN5C17	1650	500	60	470	1480	470