

KARE LT

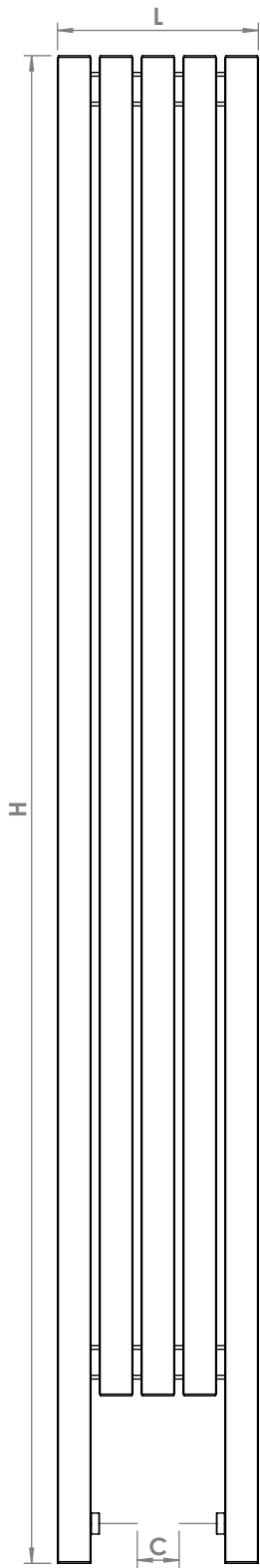

Front View

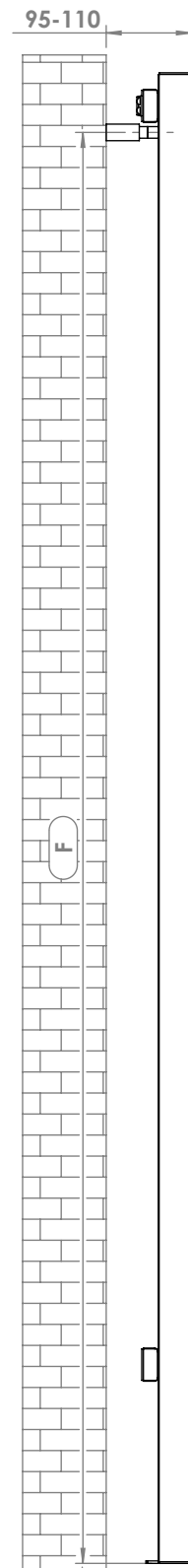

Side View

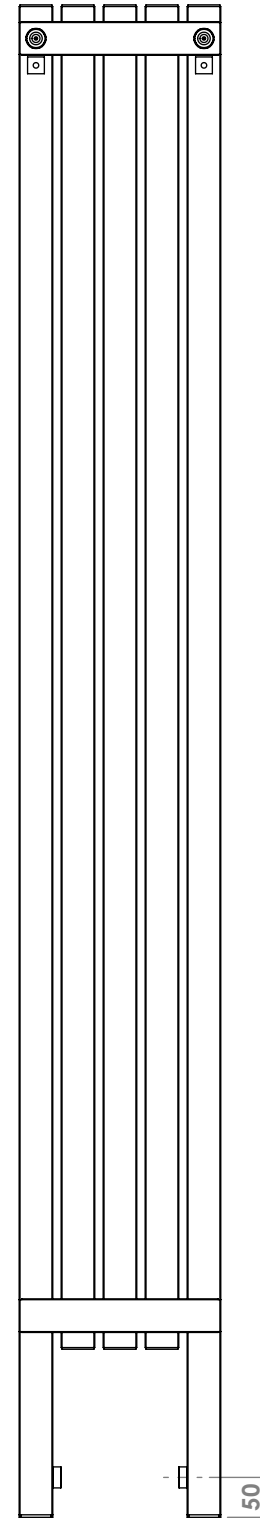

Back View

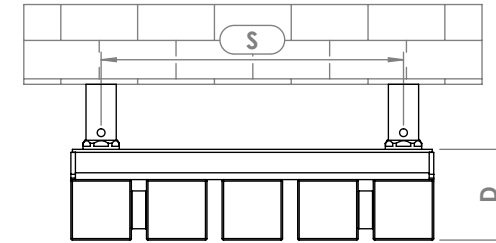

Top View

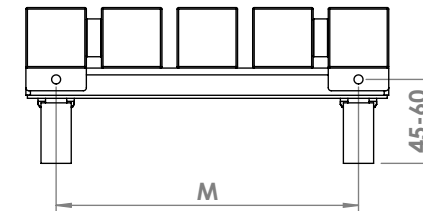

Bottom View

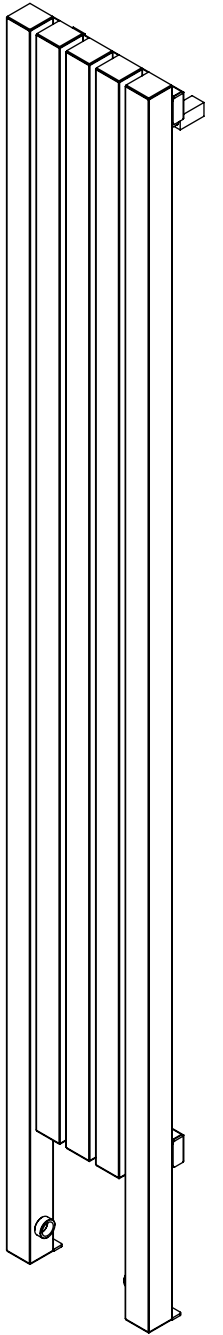



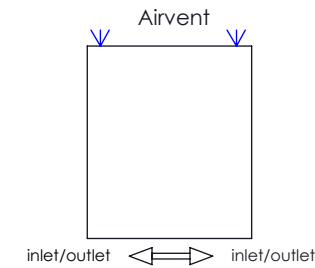



Plumbing Position:



Vertical mount
 All Dimensions are in mm
 Max. Working Pressure: 10 Bar
 Max. Working Temperature: 95° C
 Inlet / Outlet : 1/2" BSP
 Fuel : E/H/D

Manufacturing Tolerance : - 5 mm

Installation Accessories:

-  x2  x4
-  x4  x2
-  x2  x1

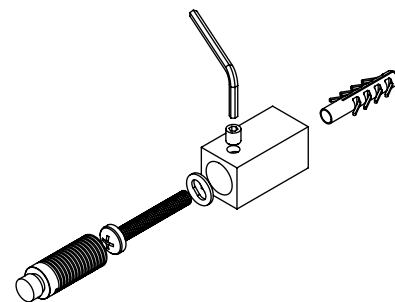

PRODUCT CODE	Height	Length	Depth	Pipe Centres	Bracket Centres		
	H mm	L mm	D mm	C mm	F mm	S mm	M mm
KRLT7-15013	1500	340	60	150	1428	300	300
KRLT5-18016	1800	240	60	50	1728	200	200
KRLT6-18016	1800	290	60	100	1728	250	250
KRLT5-20018	2000	340	60	150	1928	300	300