

WINDSOR 5W11

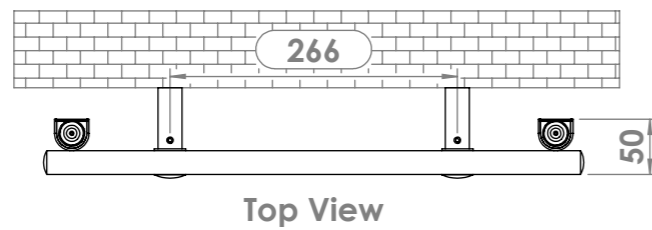

sculptural heating

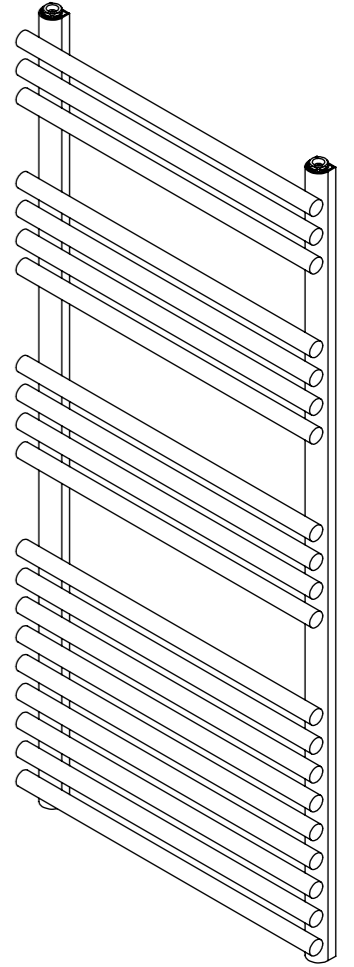
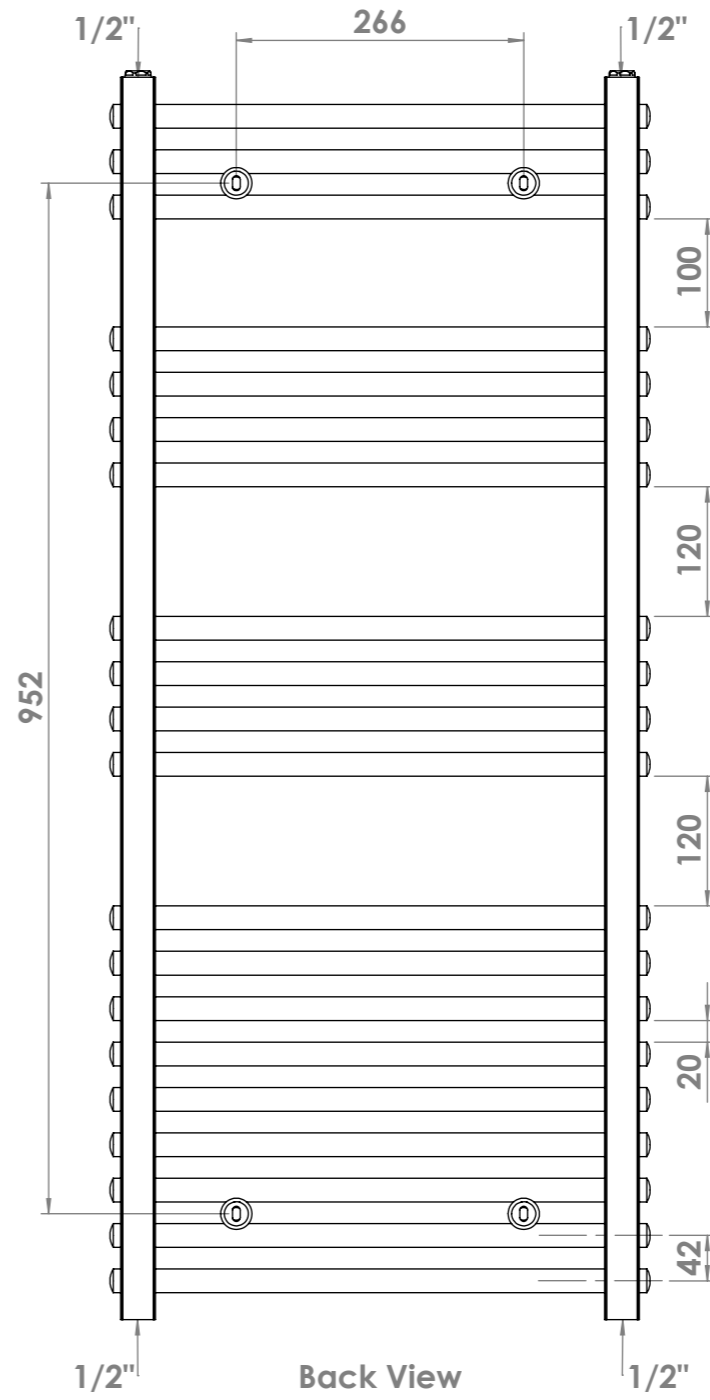
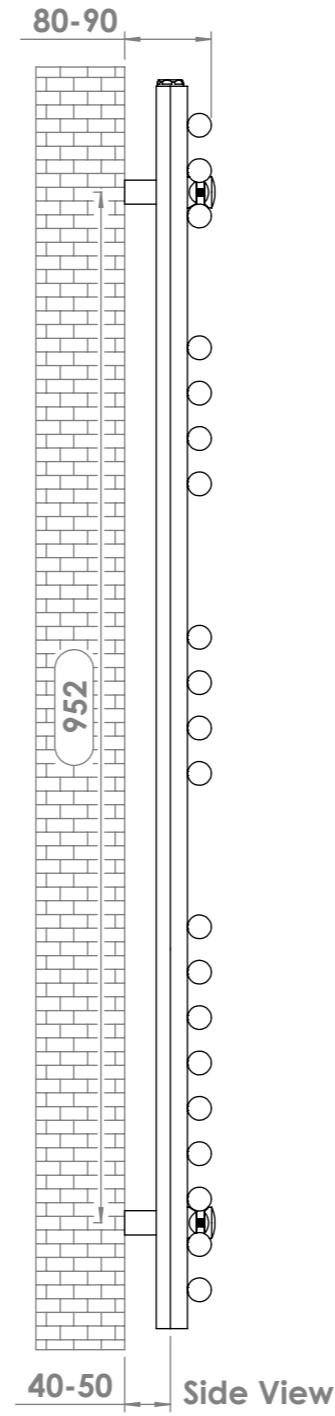
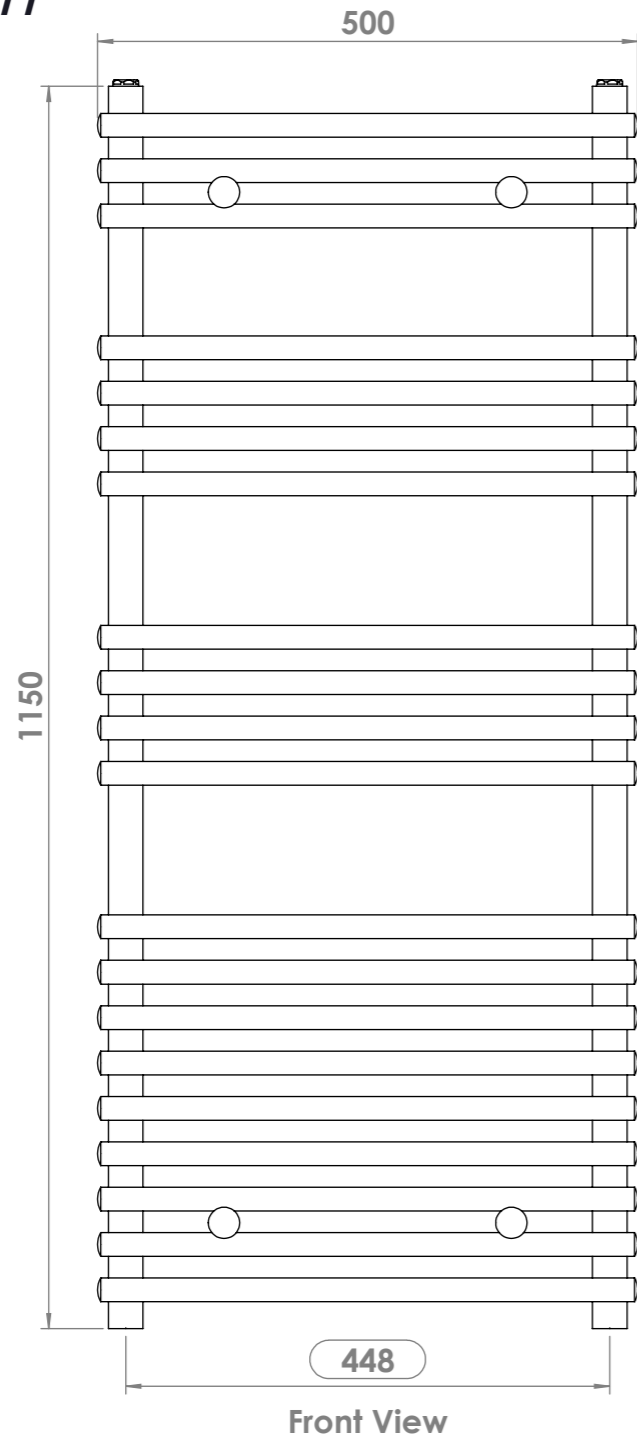

Installation Accessories:

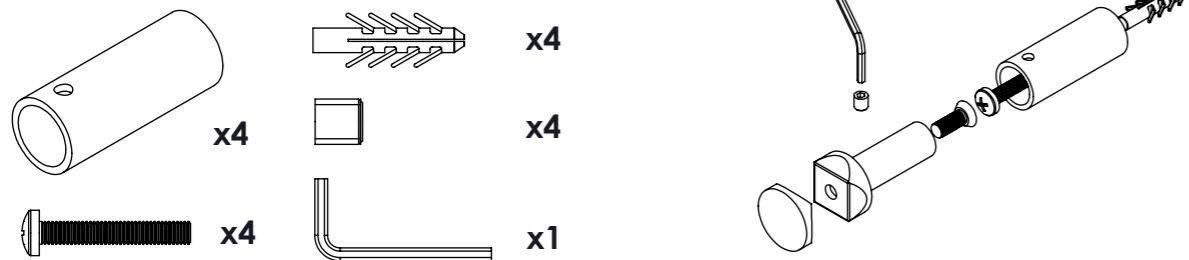

Plumbing Position:

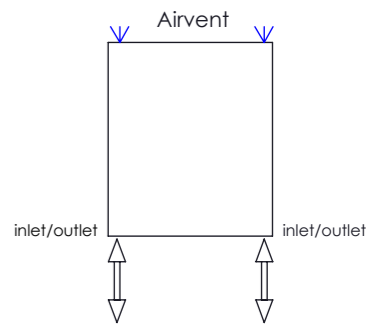

Vertical mount
 All Dimensions are in mm
 Max.Working Pressure: 10 Bar
 Max.Working Temperature: 95° C
 Inlet / Outlet : 1/2" BSP
 Fuel : E/H/D