

# WINDSOR 5W16

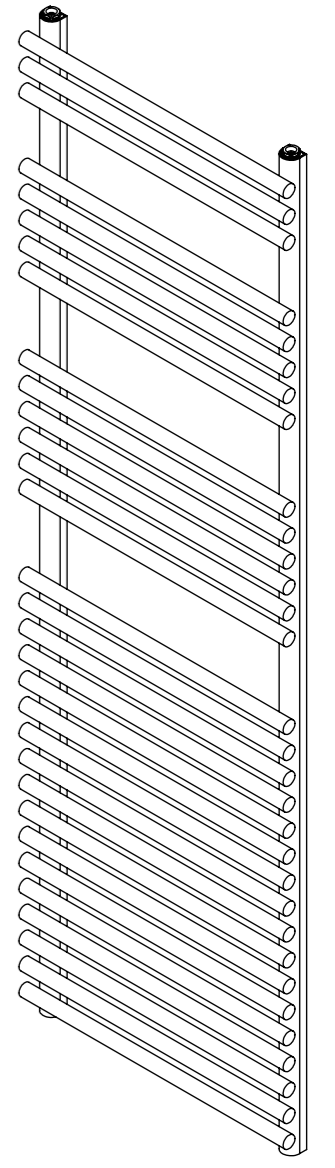

### Installation Accessories:

- x4
- x4
- x4
- x4
- x1

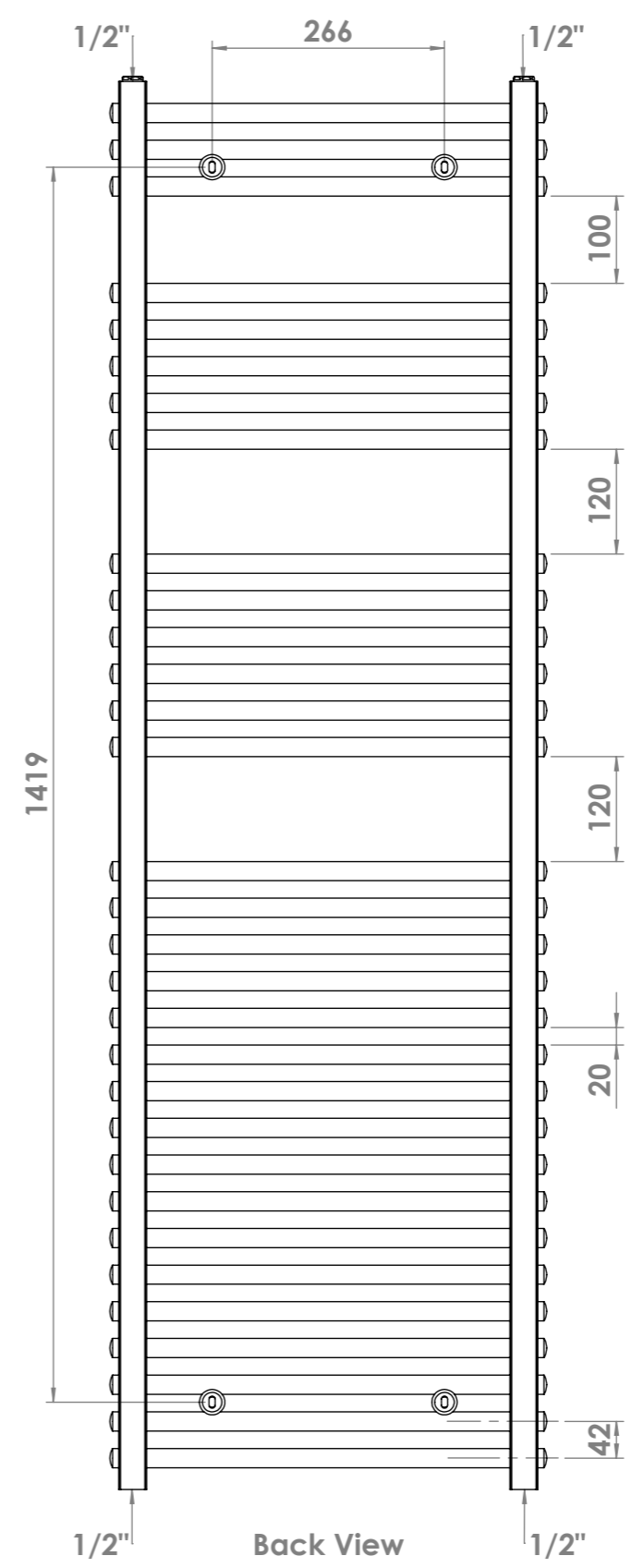
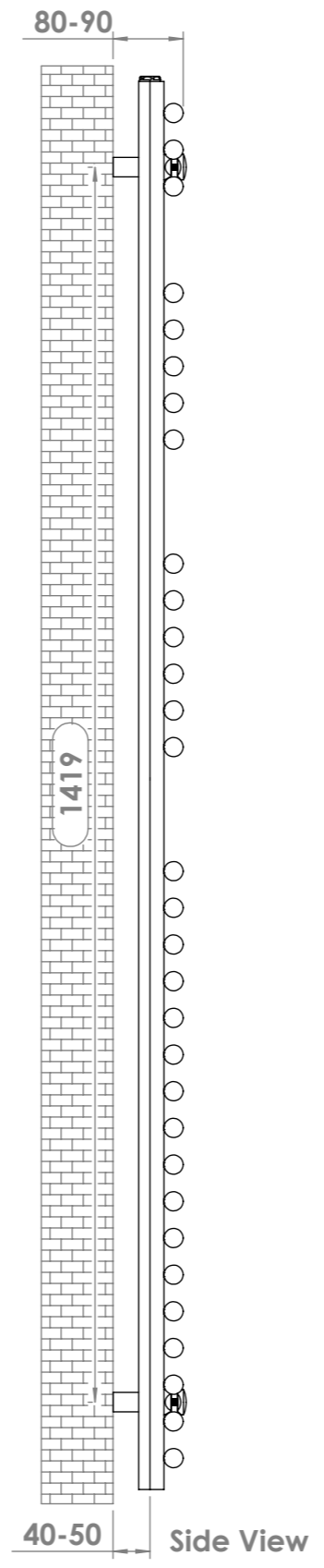
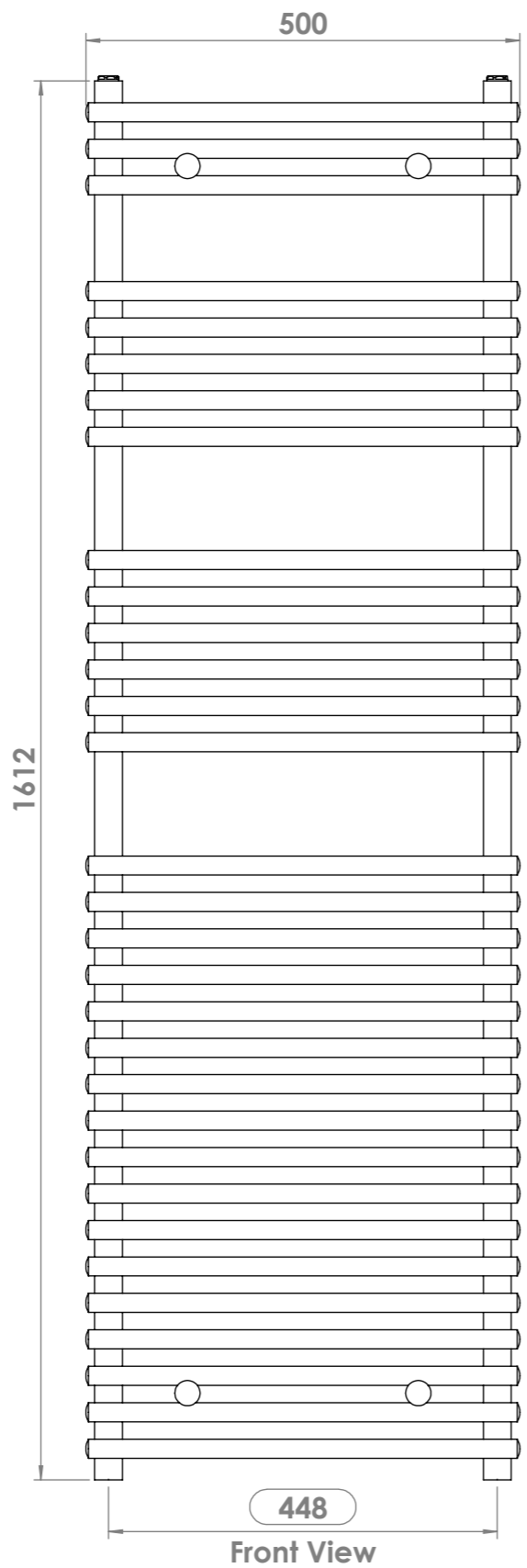
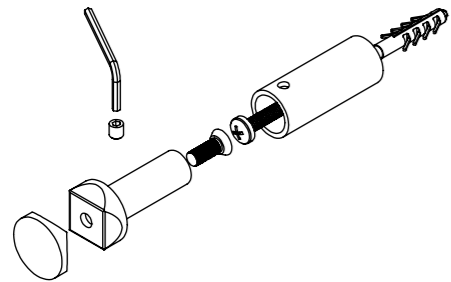
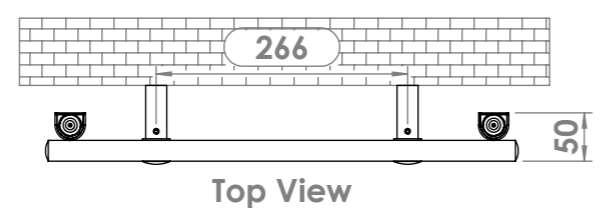

### Plumbing Position:

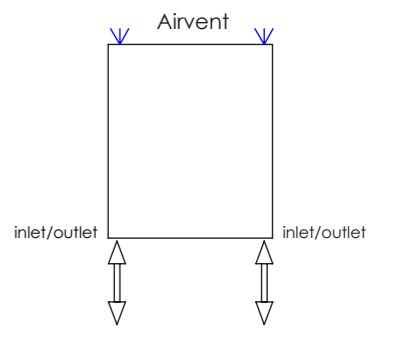

Vertical mount  
 All Dimensions are in mm  
 Max.Working Pressure: 10 Bar  
 Max.Working Temperature: 95° C  
 Inlet / Outlet : 1/2" BSP  
 Fuel : E/H/D